

FERRARI C-60
FACE FRAME
SPEC SHEET



C60 Series



UNI EN ISO 9001





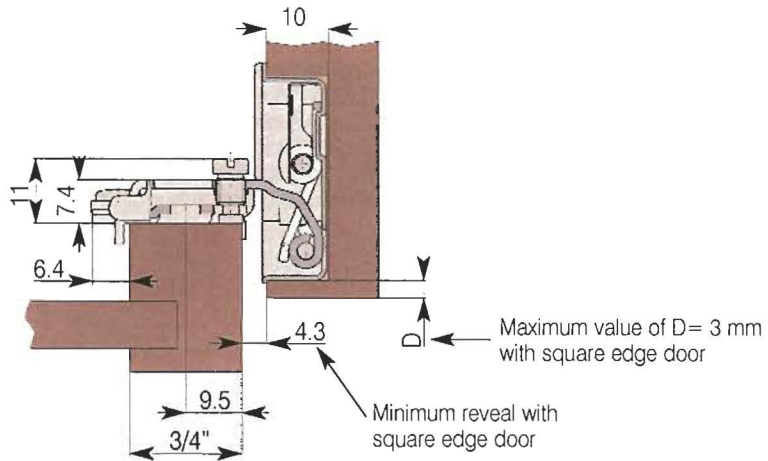

6-way adjustment frame hinge

Technical data



Range

Size in mm

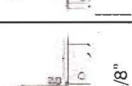
CUP BORING PATTERN AVAILABLE OVERLAYS		42		45	
		11	35	9.5	35
1/2" O.L. W/ REAR TAB		C607102GG	C607132GG	C607112GG	C607142GG
1/2" O.L. W/O REAR TAB		C60710BGG	C60713BGG	C60711BGG	C60714BGG
7/16" O.L. W/ REAR TAB		C607106GG	C607136GG	C607116GG	C607146GG
7/16" O.L. W/O REAR TAB		C60710FGG	C60713FGG	C60711FGG	C60714FGG
9/16" O.L. W/ REAR TAB		C607101GG	C607131GG	C607111GG	C607141GG
9/16" O.L. W/O REAR TAB		C60710AGG	C60713AGG	C60711AGG	C60714AGG
5/8" O.L. W/ REAR TAB		C607103GG	C607133GG	C607113GG	C607143GG
5/8" O.L. W/O REAR TAB		C60710CGG	C60713CGG	C60711CGG	C60714CGG

Ferrari hold the right to alter or amend any technical or structural specifications at any time without notice

ITALY

Agostino Ferrari S.p.a.
I - 23878 Verderio S. (LC) Via per Cornate _____
Tel. ++39.039.59001 - Fax ++39.039.5900222
Web Site://www.ferrarispa.it - e-mail: ferrarispa@ferrarispa.it

U.S.A.

Ferrari America INC.
4189 Eagle Hill Drive - Suite 110 - High Point - North Carolina - 27265 - U.S.A.
Tel. 001 336 8411445 - Fax 001 336 8413543
Web Site://www.ferrariamerica.com - e-mail: ferrariusa@northstate.net